

User's instructions

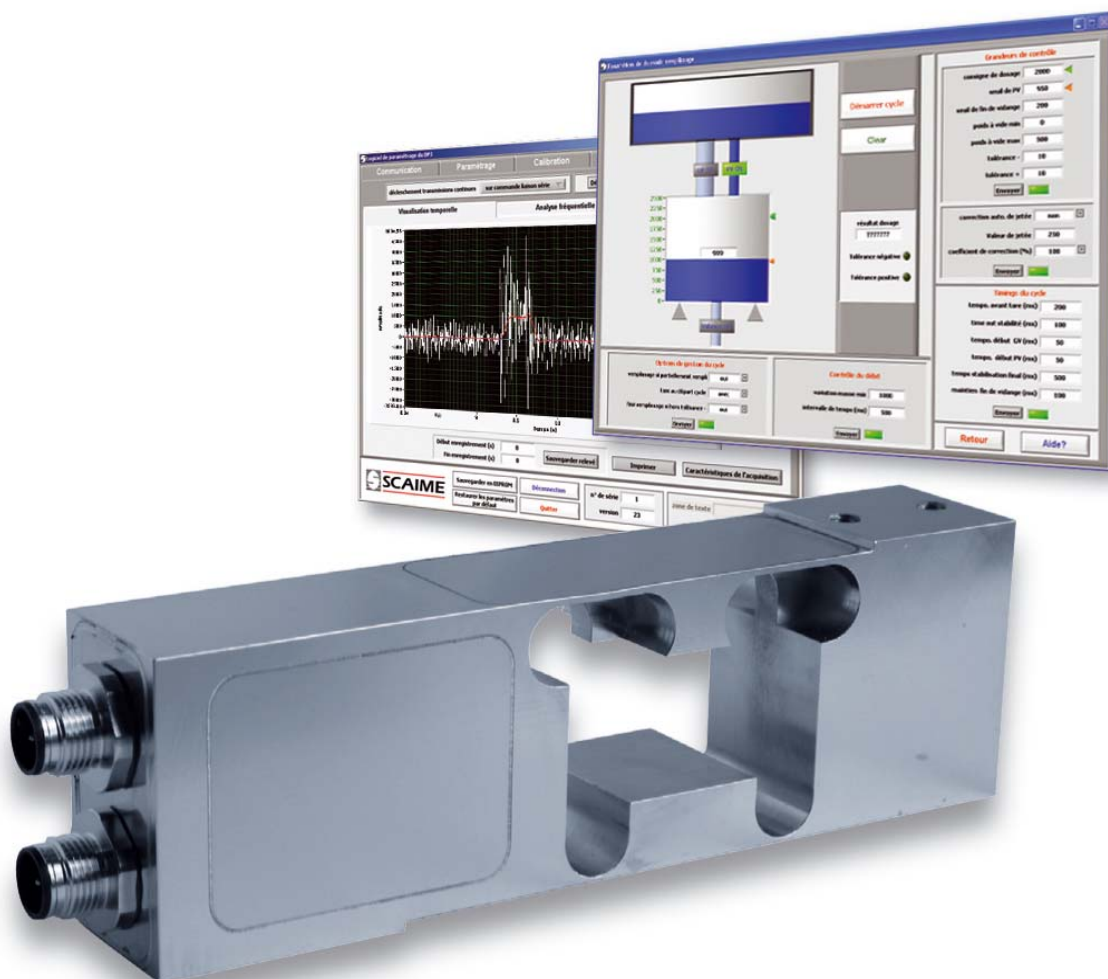

Document revisions		
version	date	description
A	12/09	- Document creation
B	05/10	- V114 firmware new functions presentation (dynamic dosing / dynamic zero)
C	01/13	- Update for AAD and V2.01 firmware release

1	GENERAL PRESENTATION :	5
1.1	Dimensions :	5
1.2	Characteristics :	6
1.2.1	Metrological characteristics :	6
1.2.2	General characteristics	6
1.2.3	Connection	7
2	INTERFACES	8
2.1	Connectors type	8
2.1.1	2x5-pins connectors version	8
2.1.2	2x8-pins connectors version	8
2.2	Connection of logical inputs	9
2.3	Connection of logical outputs	9
2.4	Communication interfaces	10
2.4.1	RS485 interface	10
2.4.2	CAN interface	10
3	COMMUNICATION :	11
3.1	Modbus RTU :	11
3.2	SCMbus :	11
3.2.1	Fast SCMbus format :	11
3.3	CANopen® :	11
4	CALIBRATION :	12
4.1	Factory default settings :	12
4.2	User's scale settings :	12
4.2.1	Theoretical scale adjustment	12
4.2.2	Physical scale adjustment	12
4.2.3	g correction	12
5	INPUTS FUNCTIONNING :	13
5.1	Inputs assignment :	13
5.2	General functions :	13
5.3	Functions attached to an operating mode :	13
6	OUTPUTS FUNCTIONING :	14
6.1	Outputs assignment :	14
6.2	general functions :	14
6.3	Functions attached to an operating mode :	14
6.4	Feeding mode in dosing process	15
7	SET POINTS :	16
8	FILTERS :	17
9	TRANSMITTER OPERATING MODE :	18
9.1	Measurement reading request :	18
9.1.1	Single measurement transmission :	18
9.1.2	Continuous measurement transmission :	18
9.2	Specific commands trough an input :	18
9.2.1	Transmit measurement (fig.3) :	18
9.2.2	Measurement window (fig.4) :	18
9.2.3	Clear	19
9.3	Specific functioning of outputs	19
10	DOSING BY FILLING FUNCTIONING MODE :	20
10.1	Starting conditions	22
10.1.1	Start cycle on request	22
10.1.2	Automatic start cycle	23
10.2	Cycle description	23
10.2.1	Flow rate control (optional)	23
10.2.2	Automatic taring at start (optional)	23
10.2.3	Dynamic dosing (optional)	23
10.2.4	Coarse feed effect neutralization time	24
10.2.5	Fine feed level	24
10.2.6	Coarse feed level	24

10.2.7	Fine feed effect neutralization time	24
10.2.8	Target weight and in-flight weight	24
10.2.9	Final stabilization time	24
10.2.10	Tolerances	24
10.2.11	High and low limits for the in-flight value	24
10.2.12	End of emptying level and emptying holding time	25
10.2.13	End of cycle waiting time	25
10.2.14	Effective end of cycle	25
10.3	Logical inputs utilization	25
10.3.1	Start cycle	25
10.3.2	Suspend current cycle	25
10.3.3	Stop cycle	25
10.3.4	Dynamic zero	25
11	DOSING BY UNLOADING FUNCTIONING MODE :	26
11.1	Reloading management	27
11.1.1	Reloading at the end of the cycle	28
11.1.2	Reloading at the start of the cycle	28
11.2	Cycle description	28
11.2.1	Flow rate control (optional)	28
11.2.2	Verification of the available product quantity	28
11.2.3	Start delay	28
11.2.4	Dynamic dosing (optional)	28
11.2.5	Coarse feed effect neutralization time	28
11.2.6	Fine feed level	28
11.2.7	Fine feed effect neutralization time	29
11.2.8	Target weight and in-flight weight	29
11.2.9	Final stabilization time	29
11.2.10	Tolerances	29
11.2.11	End of cycle waiting time	29
11.2.12	Effective end of the cycle	29
11.3	Logical inputs utilization	29
11.3.1	Start cycle	29
11.3.2	Suspend current cycle	29
11.3.3	Stop cycle	29
11.3.4	Dynamic zero	30

1 GENERAL PRESENTATION :

Manufactured in stainless steel and IP68 hermetically sealed, the **AXD-D / AAD-D** load-cell is a smart digital single point load-cell specially designed for dynamic weighing applications in harsh environments. It includes three advanced operating modes allowing dosing process control as well as high-speed measurement transmission :

- **measurements transmitter**
- **dosing by filling**
- **dosing by unloading**

AXD-D / AAD-D is provided with RS485 and CANbus outputs supporting **Modbus RTU**, **SCMbus** and **CANopen®** protocols. Each load-cell is provided with digital inputs/outputs authorizing synchronization of function with automation and alarm management.

SCAIME provides the **eNodView** software to facilitate installation of the **AXD-D / AAD-D** load-cell, to set parameters and calibrate the measurement system, for acquisition of measurements and simulation of digital filters.

1.1 Dimensions :

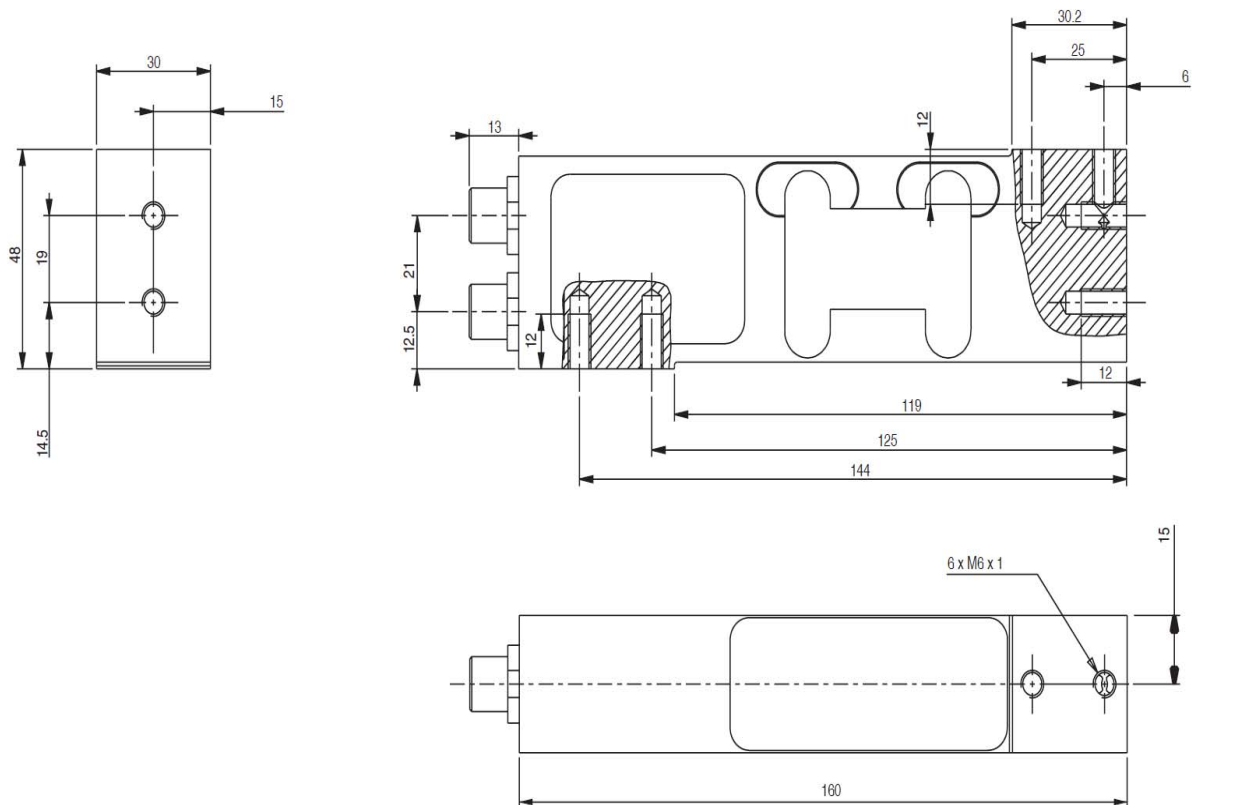

All dimensions are in mm

1.2 Characteristics :

1.2.1 Metrological characteristics :

nominal capacity (C _n) AAD-D	5 / 15 / 30 / 75	kg
nominal capacity (C _n) AXD-D / AAD-D	15 / 30 / 75	kg
combined error	±0,019	%E _{max}
zero temperature effect	±0,0011	%C _n /°C
sensibility temperature effect	±0,0016	%C _n /°C
creep (30 min)	±0,016	%C _n
maximum platform dimensions AAD	500x400 (600x400 for 75 kg)	mm
maximum platform dimensions AXD	400x400	mm

1.2.2 General characteristics

nominal sensitivity at E Max	500000				Counts
Initial zero range	± 2,5				%E _{max}
internal resolution	24				bits
Conversion rate	6,25 1600				conv./s
maximum transmission rate	1200				mes/s
power supply voltage	10 28				V _{DC}
maximum supply current	25				mA @ 24 V _{DC}
Nominal temperature range	-40 +75				°C
compensated temperature range	-10 +40				°C
safe overload	150				% E _{max}
limit load	200				% E _{max}
deflection @ E _{max} AAD	0,6	0,4	0,3	0,3	mm
deflection @ E _{max} AXD	0,25	0,2		0,2	mm
environmental protection	IP65				EN 60529
environmental protection	IP68 and IP69K				EN 60529
material AAD	aluminium				
Material AXD	stainless steel				
fixing torque	15 (17 AAD 75 kg)				Nm
Net weight AAD	0.5				kg
Net weight AXD	1,5				kg

1.2.3 Connection

Logical inputs		Unit
number	2	
type	optocouplers	
low level voltage	0 3	V _{DC}
high level voltage	10 28	V _{DC}
current at high level	10	mA @ 24 V _{DC}

Logical outputs		Unit
number	4	
type	opto-insulated static relays	
max current @ 40°C	0,4	A
max current at open state	28	V _{DC}
resistance in ON state	2	Ω

Serial communication		Unit
type	RS485 half-duplex (2 wires)	
baud rate	9600 115200	bauds
protocols	Modbus-RTU SCMbus	

CAN communication		Unit
type	CAN 2.0A	
baud rate	20 1000	kbauds
protocol	CANopen®	

Connecting		Unit
2x male connector	Lumberg RSFM 5/8 pins	

2 INTERFACES

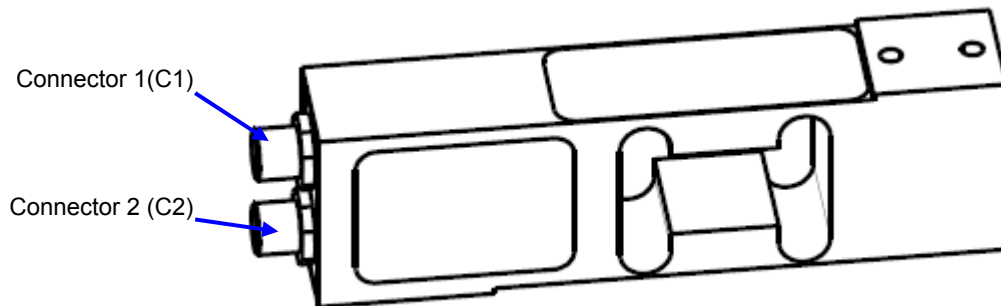

2.1 Connectors type

Two kinds of connectors are proposed on the **AXD-D / AAD-D** load-cell:

2.1.1 2x5-pins connectors version

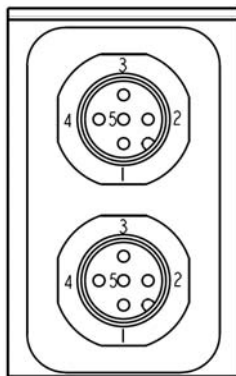

	C1	C2
1	NC	E1-
2	+Vcc	E1+
3	GND	GND
4	CANH	TA / RA
5	CANL	TB / RB

2.1.2 2x8-pins connectors version

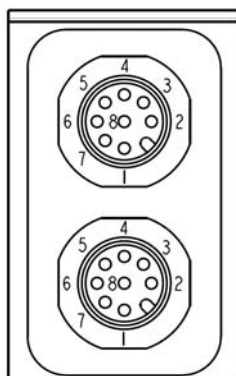

	C1	C2
1	GND	E _{COM} ⁻
2	+Vcc	E1+
3	NC	E2+
4	NC	S _{COM} ⁺
5	CANH	S1
6	CANL	S2
7	TA / RA	S3
8	TB / RB	S4

- **Note** : The **AXD-D / AAD-D** load-cell with 2x5-pins connectors do not have logical outputs available on connectors. Nevertheless these outputs *exist in a virtual state* and can be affected for specific function management. Then, their changing of state is managed by the communication bus.

2.2 Connection of logical inputs

Characteristics of opto-insulated inputs	
high level	10 to 28V _{DC} max current: 10mA @ 24VDC
low level	0 to 3 V _{DC}

Connection to a detector :

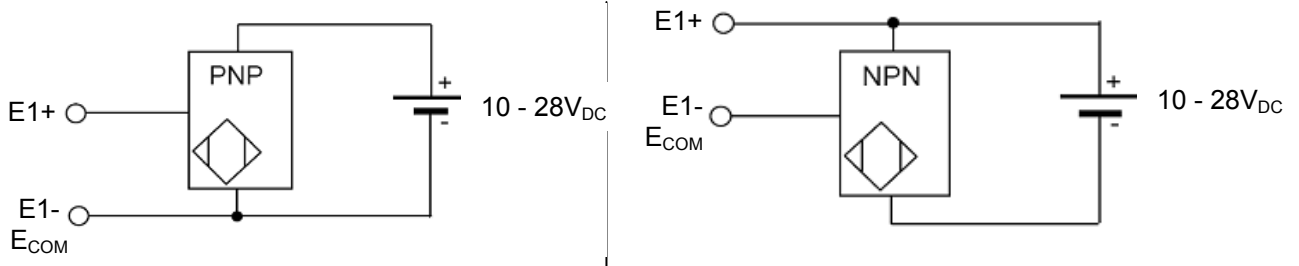

Connection to a push button (PB) :

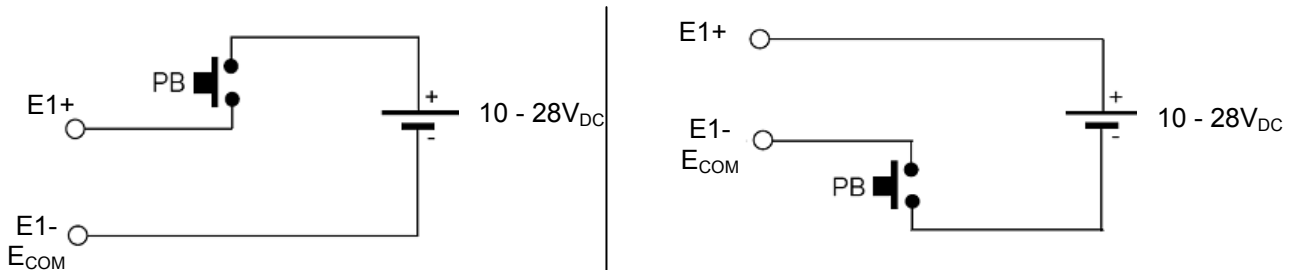

2.3 Connection of logical outputs

Opto insulated logical outputs characteristics	
max current @ 40°C	0,4A
max voltage at open state	28V _{DC}
resistance in ON state	2 Ω

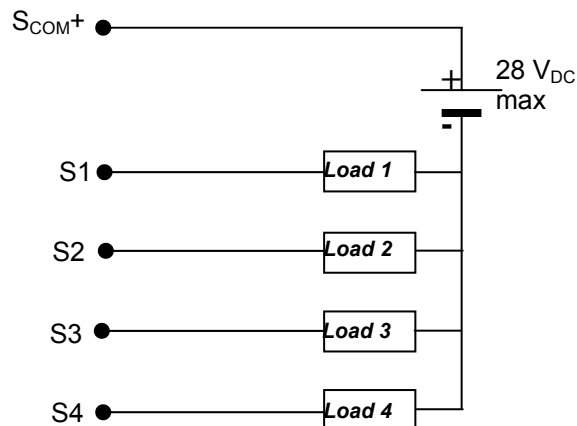

2.4 Communication interfaces

AXD-D / AAD-D load-cell has two different interfaces of communication which work the following way:

- ⇒ at power on, the load-cell starts in **CANopen® protocol**.
- ⇒ if the load-cell receives a valid RS485 frame (Modbus-RTU or SCMBus), it automatically switches into this communication mode (using the memorized communication protocol). The load cell returns to CANopen® protocol after next reset (hardware or software).

2.4.1 RS485 interface

AXD-D / AAD-D load-cell can communicate on a 2-wires RS485 bus (half-duplex) at one of the following rates:

- 9600 bauds
- 19200 bauds
- 38400 bauds
- 57600 bauds
- 115200 bauds

The connection is made through the TA/RA and TB/RB pins. Pins position depends on the load cell version:

- ⇒ 2x5-pins connectors version: pins 4 and 5 on connector C2
- ⇒ 2x8-pins connectors version: pins 7 and 8 on connector C1

It is strongly advised to use termination resistors (120 Ω) at each bus' end to ensure a good transmission quality. (The line adaptation limits the reflection effects).

The address choice, the baud rate and the used protocol (Modbus RTU or SCMBus) can be achieved by the transmission of the appropriate command on the communication bus (cf. §3).

By default (at delivery), the **AXD-D / AAD-D** load-cell is set to work using the Modbus RTU protocol at 9600 bauds at the address 01_H.

2.4.2 CAN interface

AXD-D / AAD-D load-cell can communicate through its CAN 2.0A interface using CANopen® protocol. The usable rates are the following:

- 50000 bauds
- 125000 bauds
- 250000 bauds
- 500000 bauds
- 800000 bauds
- 1000000 bauds

The connection is made through the CANH and CANL pins. Pins position depends on the load cell version cell:

- ⇒ 2x5-pins connectors version: pins 4 and 5 of the connector C1
- ⇒ 2x8-pins connectors version: pins 5 and 6 of the connector C1

To avoid signals reflections phenomena that can lead to communication problems, the CAN bus **must** be closed with termination resistors. 120 Ω resistors must to be placed at each bus' end.

By default (at delivery), the **AXD-D / AAD-D** load-cell is set to communicate at 125000 bauds with the node number 01_H.

3 COMMUNICATION :

The **AXD-D / AAD-D** load-cell can communicate using several protocols :

- **Modbus RTU**
- **SCMbus** *standard* format or *fast* format.
- **CANopen®**

⇒ Switching from **SCMbus** protocol to the **Modbus RTU** protocol (and reciprocally) can be done by software programming :

- 1) *send the corresponding command*
- 2) *send the 'storage in EEPROM' command*
- 3) **reset** (*hardware or software*) the digital load cell.

3.1 Modbus RTU :

See the description of the communication and frames in the document : **communication Modbus RTU** Ref. 195704.

3.2 SCMbus :

See the description of the communication and frames in the document : **communication SCMbus** Ref. 195706.

The **SCMbus** protocol has got similarities with **Modbus RTU** protocol. It is based on the master/slave structure, however it allows to transmit measurements continuously without collision management on the bus. This operating mode is only available in **transmitter** functioning mode.

The measurements transmission frequency depends on the baud rate, thus : transmitting 100 meas/s is impossible at 19200 bauds and lower. For fast measurement transmissions, use the **fast SCMbus format** with which 1200meas/s can be expected at 115200 bauds.

Other methods of transmitting information without any master request :

- **transmitter** mode : measurement transmission triggered by a logical input.
- **whatever the functioning mode is**, during a *physical calibration procedure* an automatic transmission is done when a step in the process is completed .

3.2.1 Fast SCMbus format :

The **fast SCMbus format** is particularly useful for measurement acquisition at the highest rate possible, for example in order to analyse dynamic behaviour. This format should only be used for point to point operation.

In order to optimize the speed, in addition to use the **fast SCMbus format**, it is preferable to configure the **AXD-D / AAD-D** load-cell in '**non-processing transmitter**'. In this operating mode, filters are disabled, set points are not managed and there is no polynomial linearization.

3.3 CANopen® :

The **AXD-D / AAD-D** load-cell supports **CANopen®** communication protocol and is compliant with 'CiA® Standard V301'. Refer to the description note : '**communication CANopen®** Ref. 195708'

4 CALIBRATION :

4.1 Factory default settings :

By default (at delivery) the **AXD-D / AAD-D** load-cell is calibrated so as to deliver 500000 points for its nominal load (5 for AAD only, 15, 30 or 75 kg). This calibration can not be erased or deleted and acts as a reference span on which is based the user's scale.

4.2 User's scale settings :

The measurements scale transmitted by the load-cell can be readjusted by two different ways :

4.2.1 Theoretical scale adjustment

It is possible to define the scale of the load-cell by a relation between the nominal load and the corresponding value to transmit. The '*max capacity*' parameter defines the number of points to display/transmit when the load-cell is submitted to a load equivalent to his nominal capacity. For example :

- For a 30 kg load cell, if the specified '*max capacity*' is 30000, the load-cell will deliver 8000 pts for a 8 kg load (1 gram calibration).
- For a 15 kg load cell, if the specified '*max capacity*' is 150000, the load-cell will deliver 80000 pts for a 8 kg load (0.1 gram calibration).

4.2.2 Physical scale adjustment

The user's span can also be defined by learning. This calibration procedure requires a standard load whose weight is perfectly known. The '*calibration load*' parameter allows to define the number of points corresponding to the standard load (for example 5000 points for a 5 kg load).

4.2.3 g correction

AXD-D / AAD-D load-cell is calibrated in Annemasse (France, Haute-Savoie). This implies that for other terrestrial geographical coordinates, a slight difference in accuracy can be observed on the measurement. In order to compensate this aptness error, it is possible to set into the load cell the value of the local gravity acceleration coefficient. The span adjustment is then made automatically.

- *Note : the **eNodView** software allows to make easily all this adjustment and, particularly the determination and the setting of the local g value.*

5 INPUTS FUNCTIONNING :

Each input can work in positive or negative logic individually. A debounce time attached to both inputs can be adjusted.

5.1 Inputs assignment :

Function	Functioning mode		
	transmitter	dosing by filling	dosing by unloading
none	•	•	•
tare	•	•	•
zero	•	•	•
transmit measurement	•		
measurement window	•		
clear	•		
start cycle		•	•
stop cycle		•	•
suspend current cycle		•	•
dynamic zero		•	•

5.2 General functions :

- *none* : inputs have no effect.

- *tare* : one or the other or both inputs can be assigned to the tare function. The tare acquisition is conditioned by a stability criterion that can be changed or inhibited. Depending on the chosen logic (positive or negative) the tare is triggered by a rising or a falling edge.

- *zero* : one or the other or both inputs can be assigned to the zero function. A new volatile zero value is acquired only if its value is within $\pm 10\%$ range of the specified capacity for a usage out of legal for trade or $\pm 2\%$ for legal for trade application. The zero acquisition is conditioned by a stability criterion that can be changed or inhibited. This zero value is a volatile value and it is cancelled after a reset.

Depending on the chosen logic (positive or negative) the zero is triggered by a rising or a falling edge.

5.3 Functions attached to an operating mode :

See corresponding sections for a complete description.

6 OUTPUTS FUNCTIONING :

Each output can work in positive or negative logic individually.

6.1 **Outputs assignment :**

Function	operating mode		
	transmitter	dosing by filling	dosing by unloading
set point	•	•	•
motion	•	•	•
defective measurement	•	•	•
dosing result available		•	•
cycle in progress		•	•
input image	•	•	•
fine feed		•	•
coarse feed		•	•
emptying		•	
reloading			•
out of tolerances		•	•
flow rate failure		•	•
dosing failure		•	•
level on request	•		

6.2 **general functions :**

- *Set point* : the outputs can be assigned to configurable set points. Output 1 is assigned to set point 1, output 2 to set point 2, output 3 to set point 3 and output 4 to set point 4.

- *Motion*: the outputs can be assigned to copying measurements stability.

- *Defective measurement* : the outputs can be assigned to copying the measurements faults. These faults are also coded in the status word :

- * Signal outside the converter analog input range
- * Signal outside the capacity on the positive side
- * Signal outside the capacity on the negative side

- *Input image* : outputs can be assigned to copying inputs state, either using the same logic or inverting the input state (negative logic). Outputs 1 and 3 are assigned to input 1, outputs 2 and 4 are assigned to input 2.

6.3 **Functions attached to an operating mode :**

See corresponding section for a complete description.

6.4 Feeding mode in dosing process

For the **filling and dosing by unloading** functioning mode, it is possible to select the activation sequency of the feed outputs :

- ⇒ *Coarse feed only then fine feed*
- ⇒ *(Coarse feed + fine feed) at the beginning of the cycle then fine feed*
- ⇒ *Coarse feed only*
- ⇒ *Fine feed / coarse feed only / fine feed*
- ⇒ *Fine feed / (coarse feed + fine feed) / fine feed*

7 SET POINTS :

Set points are characterised by a high and a low value.

Their operating mode is either **operating in hysteresis** either **operating in window** :

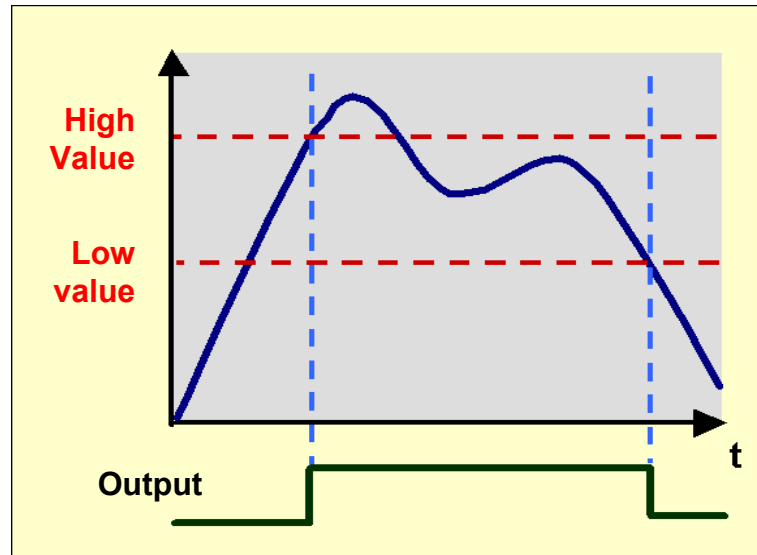

Operating in hysteresis (positive logic)

Fig. 1

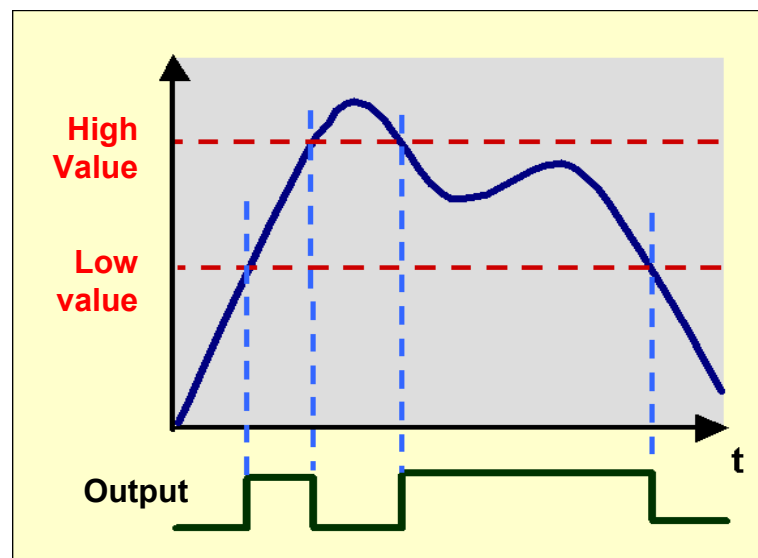

Operating in window (positive logic)

Fig. 2

The low and high values of these set points can be assigned either to (regardless the functioning mode) :

- **gross measurement**
- **net measurement**

8 FILTERS :

There are four available filtering levels :

- * Filtering related to the A/D conversion rate including rejection of the main frequency (50 Hz or 60 Hz) harmonics.
- * 2nd, 3rd or 4th order low-pass Bessel / Butterworth filter.
- * 2nd order stop-band filter
- * Self adaptive filter.

- **Filtering related to the A/D conversion** : The signal resolution is related to the conversion rate. The conversion rate might be chosen as low as possible, particularly for static applications. For dynamic applications , a compromise must be found between the measurement rate and the low-pass filter cut off frequency. The **eNodView** software can be used to determine the appropriate filter values.

Choose a measurement rate that rejects the main frequency harmonics according to the place of use, 50Hz or 60 Hz.

- **Bessel or Butterworth type low-pass filter** : a digital low-pass filter can be applied at the output of the A/D converter. The filter order is configurable (available values are 2, 3 or 4) and the coefficients that define it depend on the A/D converter rate, the wanted cut off frequency and on the chosen order. These coefficients can be easily calculated by the **eNodView** software.

- **Band-stop filter** : a 2nd order filter might be applied as an output of the low-pass filter (if used) or the A/D converter. It allows to attenuate the frequencies within a band defined by a high and a low cut off frequencies. The coefficients that define it depend on the A/D converter rate and the wanted cut off frequencies (that means the frequency bandwidth). These coefficients can be easily calculated by the **eNodView** software.

- **Self-adaptive filter** : This filter can be set in cascade after previous filters. It is particularly efficient for the static measurement but avoid using it in dynamic or dosing processes. The aim of this filter is to eliminate erratic values and to average consistent measurements.

9 TRANSMITTER OPERATING MODE :

This basic operating mode consists in transmitting calibrated measurements on the bus, possibly after filtering them and comparing them to set points level.

Measurements can be transmitted individually regardless of the communication protocol or continuously at a define frequency in **SCMbus** (*standard or fast format*) or **CANopen®** protocols.

9.1 Measurement reading request :

9.1.1 Single measurement transmission :

Regardless of the communication protocol in use.

The request can apply to :

- gross measurement.
- net measurement.
- tare value.
- measurement in A/D converter points.

9.1.2 Continuous measurement transmission :

This is possible using **standard or fast SCMbus format**, the transmission can be started by a serial command for a defined period in ms.

The request can apply to :

- gross measurement.
- net measurement.
- measurement in A/D converter points.

□ **Note** : This is very similar to operation of 'measurement window' trough an input command.

CANopen® protocol also allows to define a period at which measurement are sent on the bus without any master request.

9.2 Specific commands trough an input :

Note: If both inputs are assigned to one of the 3 functions, only the function assigned to the Input 1 is operative.

9.2.1 Transmit measurement (fig.3) :

This is only possible using standard or fast **SCMbus** format and **CANopen®** protocols. The request can apply to :

- gross measurement
- net measurement
- measurement in A/D converter points.

A single measurement is transmitted per rising or falling edge (depending on the configured logic) on the input signal.

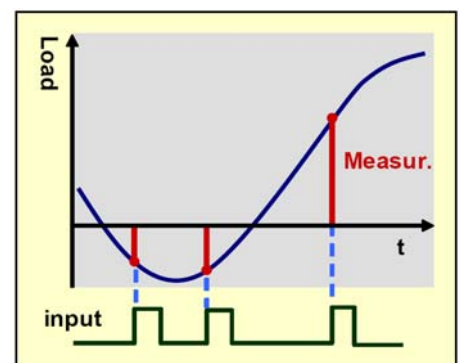

Fig. 3

9.2.2 Measurement window (fig.4) :

This is only possible using standard or fast **SCMbus** format.

The request can apply to :

- gross measurement
- net measurement
- measurement in A/D converter points.

While the input is kept at the right level, a series of measurement are transmitted at the period define by the 'sampling period' setting .

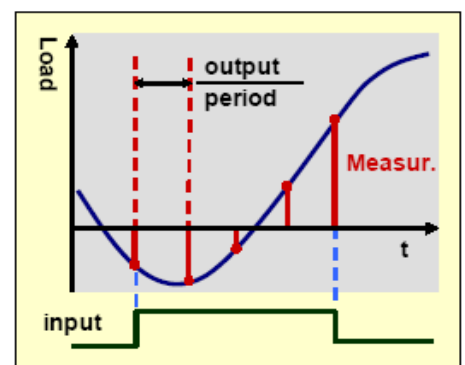

Fig. 4

9.2.3 Clear

Cancels current tare (same functioning as *'cancel tare' command*).

9.3 Specific functioning of outputs

In the **transmitter** operating mode, the outputs assigned to *functions 'fine feed', 'coarse feed', 'emptying'* or *'reloading'* are considered as affected to the function *'level on request'*.

So it is possible to force their state through the communication bus.

10 DOSING BY FILLING FUNCTIONING MODE :

The **filling** functioning mode is a way to monitor a dosing cycle of a product by measuring the weight of a receptacle placed on the load-cell. The **AXD-D / AAD-D** load-cell is used to weigh the support on which the dosed product is flowing. The process is entirely managed by the load-cell through its digital outputs (coarse fee and fine feed, errors detection, emptying, tolerances control).

Figures 5, 6 et 7 shown below represent graphically how a **filling** cycle is working and what is the influence of the variables involved.

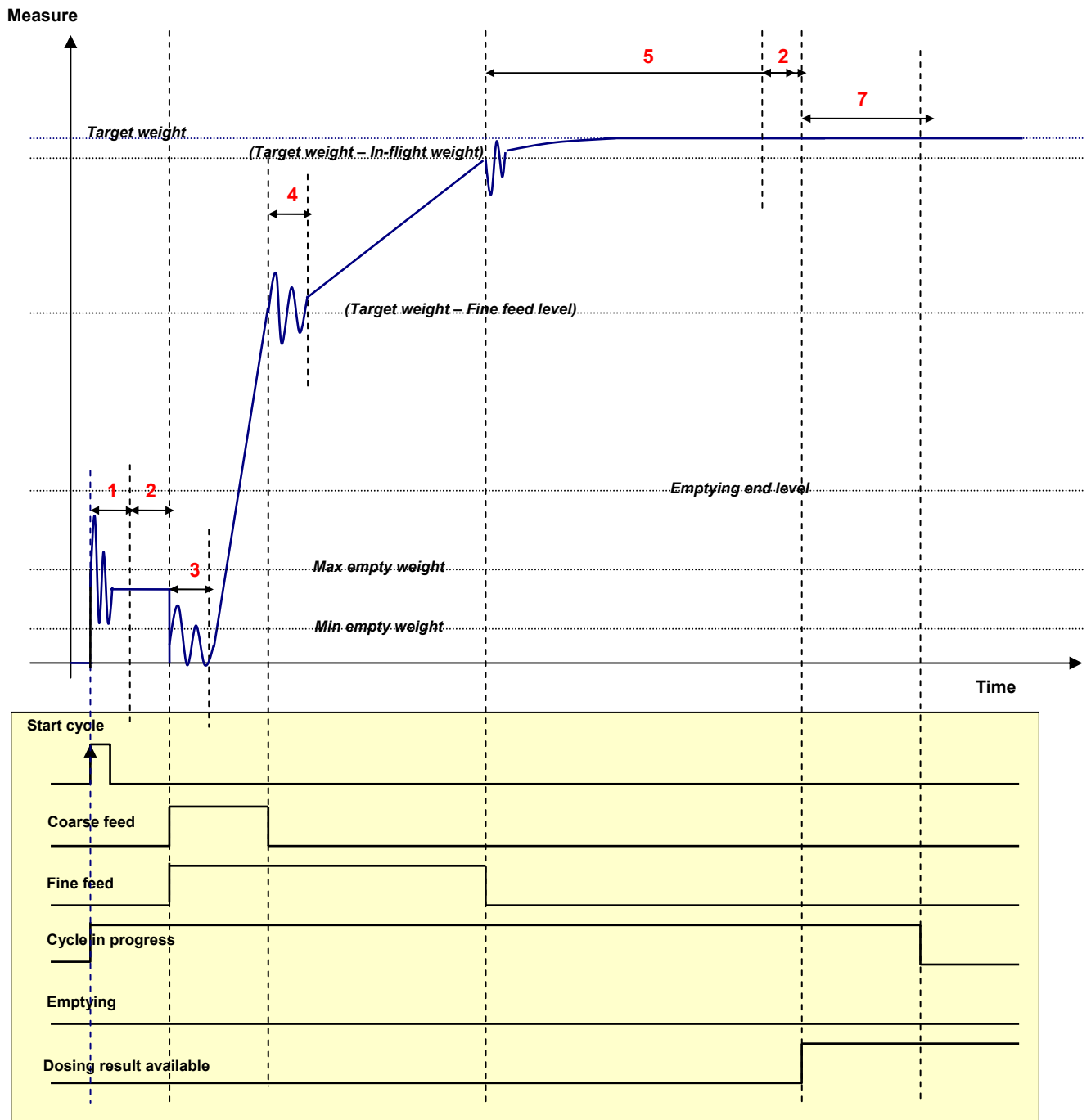

Fig. 5 : complete filling cycle without emptying phase

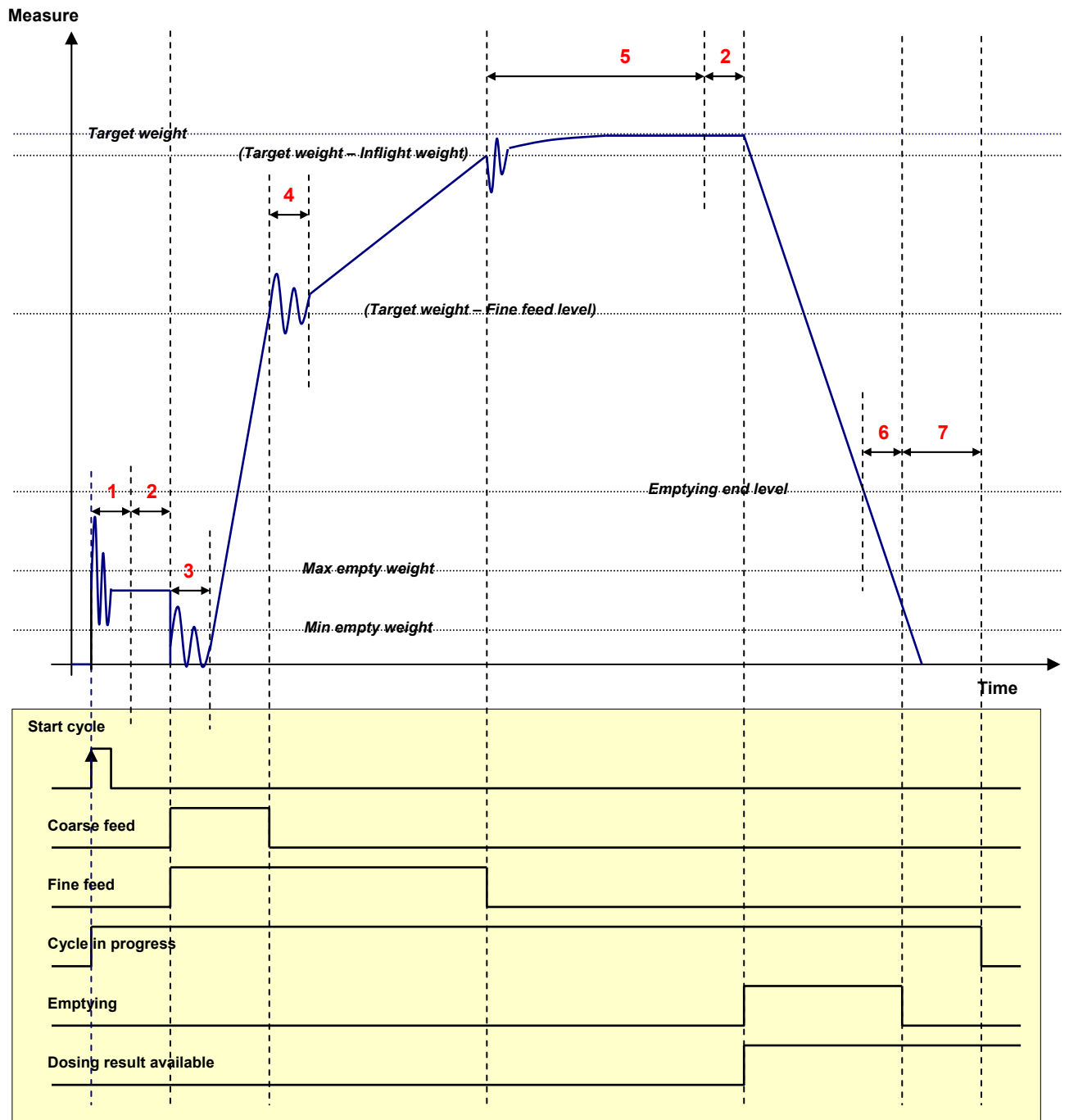

Fig. 6 : complete filling cycle with emptying phase

- * **1** : start delay
- * **2** : motion time out / average value calculation time (dynamic dosing)
- * **3** : coarse feed effect neutralization time
- * **4** : fine feed effect neutralization time
- * **5** : final stabilization time
- * **6** : emptying holding time
- * **7** : end of cycle waiting time

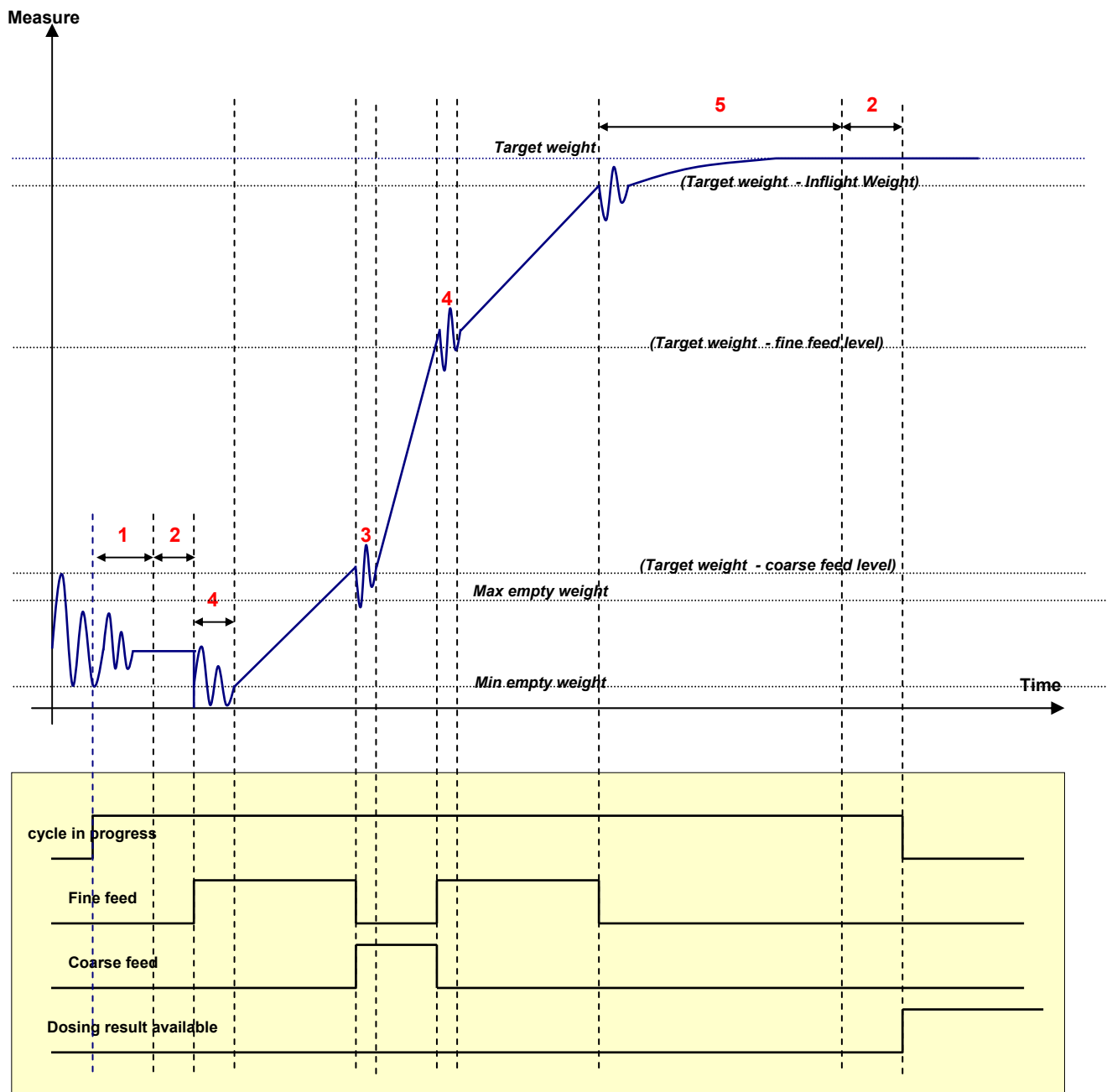

Fig. 7 : complete filling cycle with automatic start and 'fine feed/coarse feed/fine feed' sequence

- * **1** : start delay
- * **2** : motion time out / average value calculation time (dynamic dosing)
- * **4** : fine feed effect neutralization time
- * **3** : coarse feed effect neutralization time
- * **5** : final stabilization time

10.1 Starting conditions

10.1.1 Start cycle on request

After the reception of the 'start cycle' command, or the activation (rising or falling edge depending on the logic) of a digital input assigned to this function, the filling cycle starts as soon as the 'start delay' has elapsed. It also causes an output assigned to the 'cycle in progress' function to be set.

The following tab recaps the possible cases encountered when starting a cycle :

automatic taring at start	restart if suspended authorization	weight value	action
active		min empty weight < gross weight < max empty weight	taring then start
		regardless the gross weight IF min empty weight = max empty weight = 0	
		other case	cycle cancelled, error reporting
	allowed	regardless the weight value IF last cycle was suspended	cycle recovery from last step (taring possible)
inactive		min empty weight < gross weight < max empty weight	no tare starting from the net current value
		regardless the gross weight IF min empty weight = max empty weight = 0	
		other case	cycle cancelled, error reporting
	allowed	regardless the weight value IF last cycle was suspended	cycle recovery from last step (no tare)

10.1.2 Automatic start cycle

The **AXD-D / AAD-D** load-cell can be also configured to start the filling cycle when a packaging is detected at the weighing zone.

A cycle starts as soon as the gross weight value remains between '*min empty weight*' and '*max empty weight*' values during a duration equal to the '*start delay*'. This time is reset if the gross weight runs out of the specified range.

10.2 Cycle description

10.2.1 Flow rate control (optional)

The **AXD-D / AAD-D** load-cell includes a flow rate control system. It makes possible to check that the flow rate during the cycle is sufficient. The device controls that the flow rate remains equal or superior to a minimal value. If it's not the case, an output assigned to '*dosing failure*' or '*flow rate failure*' is set and the cycle is suspended if the cycle recovery option is active else it is stopped.

The flow rate control is defined by two parameters :

- * a time interval (if = 0, the flow rate control is not used) defined in ms
- * a minimal weight variation

10.2.2 Automatic taring at start (optional)

If the '*automatic taring at start*' option is active, as soon as the '*start delay*' has elapsed, the tare acquisition is done if measurements are stable. If at the end of the '*motion time out*' delay time, no stability can be found, the tare value is equal to the last gross current value.

10.2.3 Dynamic dosing (optional)

The '*dynamic dosing*' option allows to limit the impact of instability on the behaviour of the dosing cycles. Its activation has the following effects :

- * changing in the final result determination :
 - ⇒ the '*motion time out*' that follows the '*final stabilization time*' is used to calculate the net average value. This calculation result gives the new dosing result
 - ⇒ a standard deviation is also determined for every new result.

- * changing in the tare acquisition method (if the '*automatic taring at start*' option is enabled) :
 - ⇒ the '*motion time out*' that follows the '*start delay*' is used to calculate the gross average value. This calculation result gives the new tare value and the cycle only starts if this result is comprised between the '*min empty weight*' and the '*max empty weight*' (or if both values are set to 0)
 - ⇒ a standard deviation is also determined for every new tare acquisition.

10.2.4 Coarse feed effect neutralization time

This delay defined in milliseconds allows to ignore the effect of the coarse feed starting on the measurement signal and especially the product impact into the receiver. During this delay time, the flow rate control and the level comparisons are inhibited.

10.2.5 Fine feed level

If the level (**target weight – fine feed**) is crossed the '*coarse feed*' output is immediately disabled. It is ignored if only the coarse feed is used (cf. §6.4).

10.2.6 Coarse feed level

In case of a cycle in which fine feed is used before the coarse feed (Fine feed/Coarse feed/Fine feed or Fine feed/Coarse + fine feed/Fine feed), the coarse feed starts as soon as the net weight value crosses the (**weight target – coarse feed level**) level.

10.2.7 Fine feed effect neutralization time

Depending on the feeding mode, this delay defined in milliseconds allows to ignore the effect of the coarse feed ending or the effect of the fine feed starting, on the measurement signal and especially the changing in the flow rate. During this delay time, the flow rate control and the level comparisons are inhibited.

10.2.8 Target weight and in-flight weight

The '*fine feed*' disabling occurs when the level (**target weight – in-flight level**) is crossed. The in-flight weight value allows therefore to quantify the weight of product that carries on falling after the output inhibition and so to avoid a systematic overload of the receiver. This value can be automatically adjusted, the correction amplitude is affected by a percentage that can be configured. It is also possible to have a stronger correction (x3) coefficient as the result is out of the fixed tolerance range.

10.2.9 Final stabilization time

This delay time corresponds to the minimal necessary duration for the stabilization of the weight before the determination of the result and the control of tolerances. When it is over, the '*motion time out*' delay time begins. If the stability cannot be found within this duration, the dosing result compared to the tolerances is equal to the last net measurement value.

10.2.10 Tolerances

The dosing result is compared to 2 limit values in order to check if it is acceptable.

- * a high tolerance (*tolerance +*) or tolerance in excess :
 - ⇒ if the difference **| (target weight – dosing result) | > tolerance +**
where **(target weight – dosing result) < 0**, the '*out of tolerances*' and '*dosing failure*' outputs are activated.
- * a low tolerance (*tolerance -*) or tolerance in default :
 - ⇒ if the difference **| (target weight – dosing result) | > tolerance -**
where **(target weight – dosing result) > 0**, the '*out of tolerances*' or '*dosing failure*' outputs are activated. If the option '*Use Fine Feed if out of low tolerance -*' is active, the fine feed is restarted.

If the updated result is out of tolerances and if the '*automatic in-flight correction*' option is active the in-flight weight value is corrected according to the equation :

$$\text{in-flight weight} = \text{in-flight weight} + (\text{dosing result} - \text{target weight}) \times \text{correction coeff}$$

Once the dosing result is updated and compared to the tolerances an output assigned to the '*dosing result available*' is set. Then, the cycle ends after the '*end of cycle waiting time*' or the emptying phase begins.

10.2.11 High and low limits for the in-flight value

If the automatic correction of the in-flight value is used, the value is updated at each cycle except if it passes the specified high and low values. In this case the last value is conserved.

10.2.12 End of emptying level and emptying holding time

During the emptying phase, an output assigned to the 'emptying' function remains active until the 'emptying holding time' has elapsed after that gross measurement has become inferior to the 'end of emptying level'.

10.2.13 End of cycle waiting time

This delay time is triggered after the control of tolerances if the emptying phase is not used else it takes place just after the 'emptying holding time'.

10.2.14 Effective end of cycle

When the 'end of cycle waiting time' is over, an output assigned to the 'cycle in progress' function is disabled and the statistic variables (number of cycles, average value, running total and standard deviation) are updated.

10.3 Logical inputs utilization

10.3.1 Start cycle

If all the starting conditions are respected (cf. §10.1.1), a rising or a falling edge (depending on the configured logic) on this input causes a new feeding cycle to be started else an error is reported by a 'dosing failure' output and into a read-only diagnostic register.

10.3.2 Suspend current cycle

This input function has got two different effects :

- * if the 'relaunch cycle if suspended' option is inactive : this edge-active input causes the feeding cycle to be stopped inhibiting the different outputs involved.
- * else the cycle is suspended until a new request of starting the cycle is activated.

10.3.3 Stop cycle

This edge-active input causes the feeding cycle to be stopped inhibiting the different outputs involved.

10.3.4 Dynamic zero

If an input assigned to 'dynamic zero' is activated or if a 'dynamic zero' command is received, the **AXD-D / AAD-D** load cell calculates the gross measurement average value during a configurable time ('dynamic zero time'). This value becomes the new effective zero value if it comprised within a $\pm 10\%$ of the specified maximum capacity. Stability is not required.

11 DOSING BY UNLOADING FUNCTIONING MODE :

The **dosing by unloading** operating mode is a way to monitor a dosing cycle of a product by measuring the weight in loss from a tank equipped with a **AXD-D / AAD-D** load-cell. In this operating mode, the process is entirely managed by the **AXD-D / AAD-D** load-cell through its digital outputs (coarse feed and fine feed management, errors detection, emptying, tolerances control).

Figures 8 et 9 shown below represent graphically how a **dosing by unloading** cycle is working and what is the influence of the variables involved.

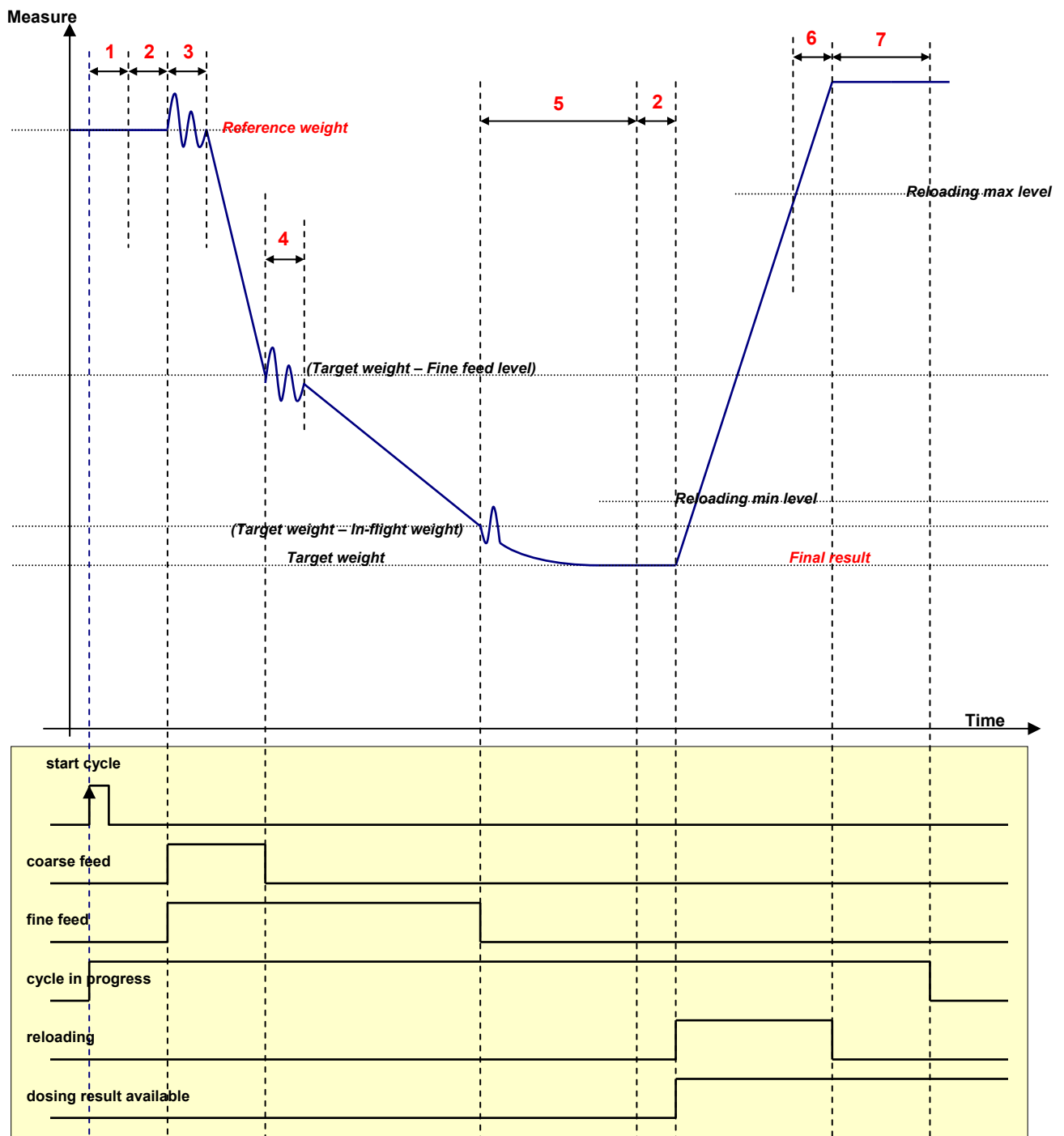

Fig. 8 : dosing by unloading cycle with reloading phase at the end of the cycle

Note : Except the '*reloading max and min levels*', the variables used to delimit the phases of the cycle on the graph are related to the reference weight.

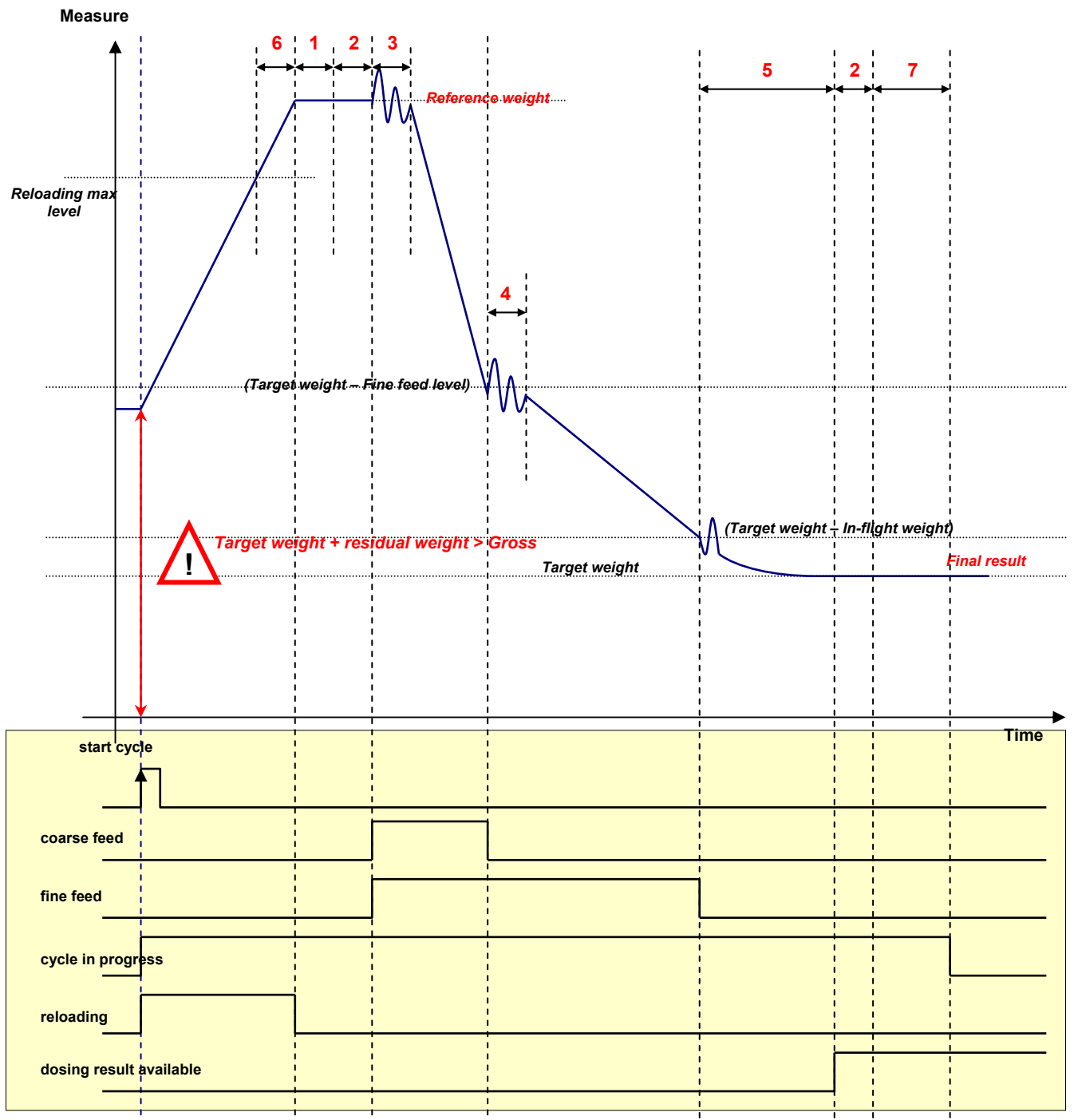

Fig. 9 : dosing by unloading cycle with reloading phase at the start of the cycle

- * **1** : start delay
- * **2** : motion time out / average value calculation time (dynamic dosing)
- * **3** : coarse feed effect neutralization time
- * **4** : fine feed effect neutralization time
- * **5** : final stabilization time
- * **6** : reloading holding time
- * **7** : end of cycle waiting time

11.1 Reloading management

AXD-D / AAD-D load-cell provides two mechanisms (optional) for reloading management. They allow the **AXD-D / AAD-D** load-cell to enter a reloading phase in case of a lack of product in the tank.

11.1.1 Reloading at the end of the cycle

An output assigned to the 'reloading' function is automatically set if after the result determination the gross measurement is lower than the 'reloading min level'. The output remains active until the 'reloading max level' has been exceeded then during the 'reloading holding time'.

11.1.2 Reloading at the start of the cycle

At the beginning of each cycle, the **AXD-D / AAD-D** load-cell checks that there is enough product to reach the dosing target weight. Else if the reloading mode is set to 'at the start of the cycle', an output assigned to the 'reloading' function is automatically set active until the gross measurement gets superior to the 'reloading max level'. It remains then active during the 'reloading holding time'.

At the end of the reloading phase, the dosing cycle begins normally.

11.2 Cycle description

11.2.1 Flow rate control (optional)

AXD-D / AAD-D load-cell includes a flow rate control system. It makes possible to check that the flow rate during the cycle is sufficient. The device controls that the flow rate remains equal or superior to a minimal value. If it is not the case, an output assigned to 'dosing failure' or 'flow rate failure' is set and the cycle is suspended if the cycle recovery option is active else it is stopped.

The flow rate control is defined by two parameters :

- * a time interval (if = 0, the flow rate control is not used)
- * a minimum weight variation

11.2.2 Verification of the available product quantity

At the beginning of each cycle, the **AXD-D / AAD-D** load-cell checks that there is enough product to reach the dosing target weight. If the gross measurement is inferior to the amount (*target weight + residual weight*), three different cases can occur depending on the selected reloading mode :

- ⇒ **none** : an error is reported by an output assigned to the 'dosing failure' function and into a read-only diagnostic register. The new cycle is aborted.
- ⇒ **at the end of the cycle** : an error is reported by an output assigned to the 'dosing failure' function and into a read-only diagnostic register. The new cycle is aborted.
- ⇒ **at the start of the cycle**: the **AXD-D / AAD-D** load-cell starts the reloading phase.

11.2.3 Start delay

When the 'start delay' is over the reference weight acquisition is done if measurements are stable. If at the end of the 'motion time out' delay time, no stability can be found, the reference weight value is equal to the gross measurement current value.

11.2.4 Dynamic dosing (optional)

The 'dynamic dosing' option allows to limit the impact of instability on the behaviour of the dosing cycles. Its activation has the following effects :

- * changing in the final result determination :
 - ⇒ the 'motion time out' that follows the 'final stabilization time' is used to calculate the gross measurement average value. This calculation result gives the new dosing result
 - ⇒ a standard deviation is also determined for every new result.
- * changing in the reference weight acquisition method :
 - ⇒ the 'motion time out' that follows the 'start delay' is used to calculate the gross measurement average value. This calculation result gives the new reference weight.
 - ⇒ a standard deviation is also determined for every new reference weight acquisition.

11.2.5 Coarse feed effect neutralization time

This delay, defined in milliseconds, allows to ignore the effect on the measurement signal of the coarse feed starting. During this delay time, the flow rate control and the level comparisons are inhibited.

11.2.6 Fine feed level

If the gross measurement decreasing gets superior to (target weight – fine feed level), the 'coarse feed' output is immediately disabled. (↔ **reference weight – gross measurement ≥ (target weight – fine feed level)**)). It is ignored if only the coarse feed is used (cf. §6.4).

11.2.7 Fine feed effect neutralization time

This delay, defined in milliseconds, allows ignoring the effect of the coarse feed ending on the measurement signal and especially the changing in the flow rate. During this delay time, the flow rate control and the level comparisons are inhibited.

11.2.8 Target weight and in-flight weight

The 'fine feed' disabling occurs when the gross measurement decreasing is superior to the (**target weight – in-flight weight**) level. The in-flight weight value allows therefore to quantify the weight of product that carries on falling after the output inhibition and so to avoid a systematic overload. This value can be automatically adjusted, the correction amplitude is affected by a percentage that can be configured. (cf. §10.2.9). It is also possible to have a stronger correction (x3) coefficient as the result is out of the fixed tolerance range.

(↔ **reference weight – gross measurement ≥ (target weight – in-flight weight)**)

11.2.9 Final stabilization time

This delay time corresponds to the minimum necessary duration for the stabilization of the weight before the determination of the result and the control of tolerances.

When it is over, the 'motion time out' delay time begins. If the stability can not be found within this duration, the dosing result compared to the tolerances is equal to the last gross measurement value.

11.2.10 Tolerances

The dosing result is compared to 2 limit values in order to check that it is included within an acceptable range.

- * a high tolerance (tolerance +) or tolerance in excess :
 - ⇒ if the difference **| (target weight – dosing result) | > tolerance +** where **(target weight – dosing result) < 0**, the 'out of tolerances' and 'dosing failure' outputs are activated.
- * a low tolerance (tolerance -) or tolerance in default :
 - ⇒ if the difference **| (target weight – dosing result) | > tolerance -** where **(target weight – dosing result) > 0**, the 'out of tolerances' or 'dosing failure' outputs are activated. If the 'use Fine Feed if out of low tolerance -' is active, the fine feed is restarted.

11.2.11 End of cycle waiting time

This delay time is triggered after the control of tolerances or after the end of the reloading phase if the reloading mode is set to 'at the end of the cycle'.

11.2.12 Effective end of the cycle

When the 'end of cycle waiting time' is over, an output assigned to the 'cycle in progress' function is disabled and the statistic variables (number of cycles, average value, running total and standard deviation) are updated.

If the reloading mode is set to 'at the end of the cycle' and if the gross measurement is inferior to the 'reloading min level', the reloading phase starts (cf. §11.2.11) and the effective end of the cycle ('cycle in progress' inhibition and statistic variables update) occurs when this phase is over.

11.3 Logical inputs utilization

11.3.1 Start cycle

If all the starting conditions are respected (cf. §11.2.2), a rising or a falling edge (depending on the configured logic) on this input, causes a new dosing cycle by unloading, else an error is reported by a 'dosing failure' output and into the read-only diagnostic register.

11.3.2 Suspend current cycle

This input function has got two different effects :

if the 'relaunch cycle if suspended' option is inactive : this edge-active input causes the feeding cycle to be stopped inhibiting the different outputs involved. Else the cycle is suspended until a new request of starting the cycle that causes the cycle to continue from its last step.

11.3.3 Stop cycle

This edge-active input causes the feeding cycle to be stopped inhibiting the different outputs involved.

11.3.4 Dynamic zero

If an input assigned to 'dynamic zero' is activated or if a 'dynamic zero' command is received, the **AXD-D / AAD-D** load cell calculates the gross measurement average value during a configurable time ('dynamic zero time'). This value becomes the new effective zero value if it comprised within a $\pm 10\%$ of the specified maximum capacity. Stability is not required.